

FLOOR BOX

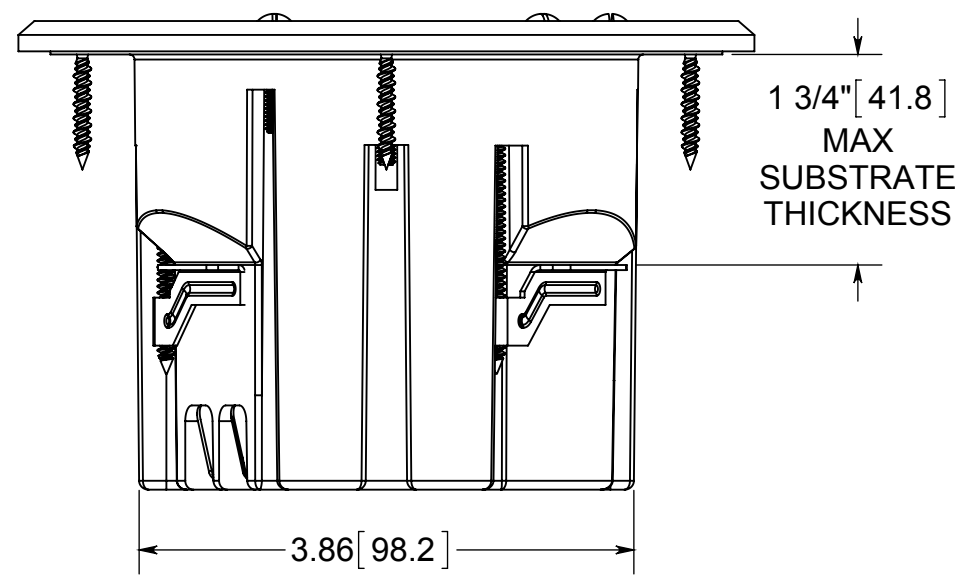
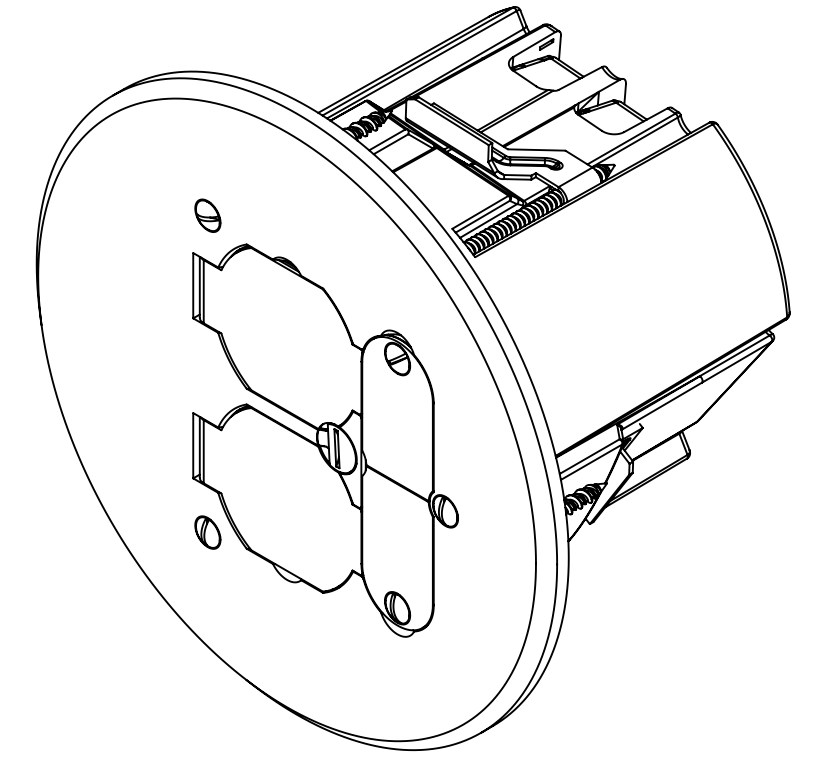
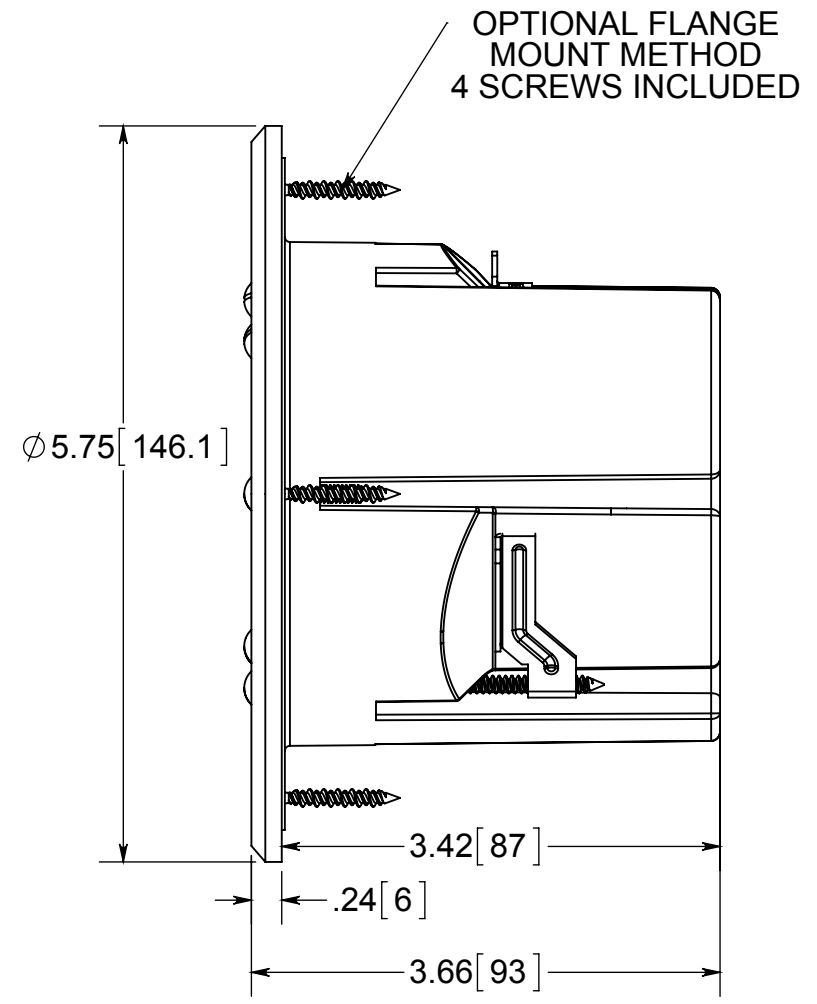
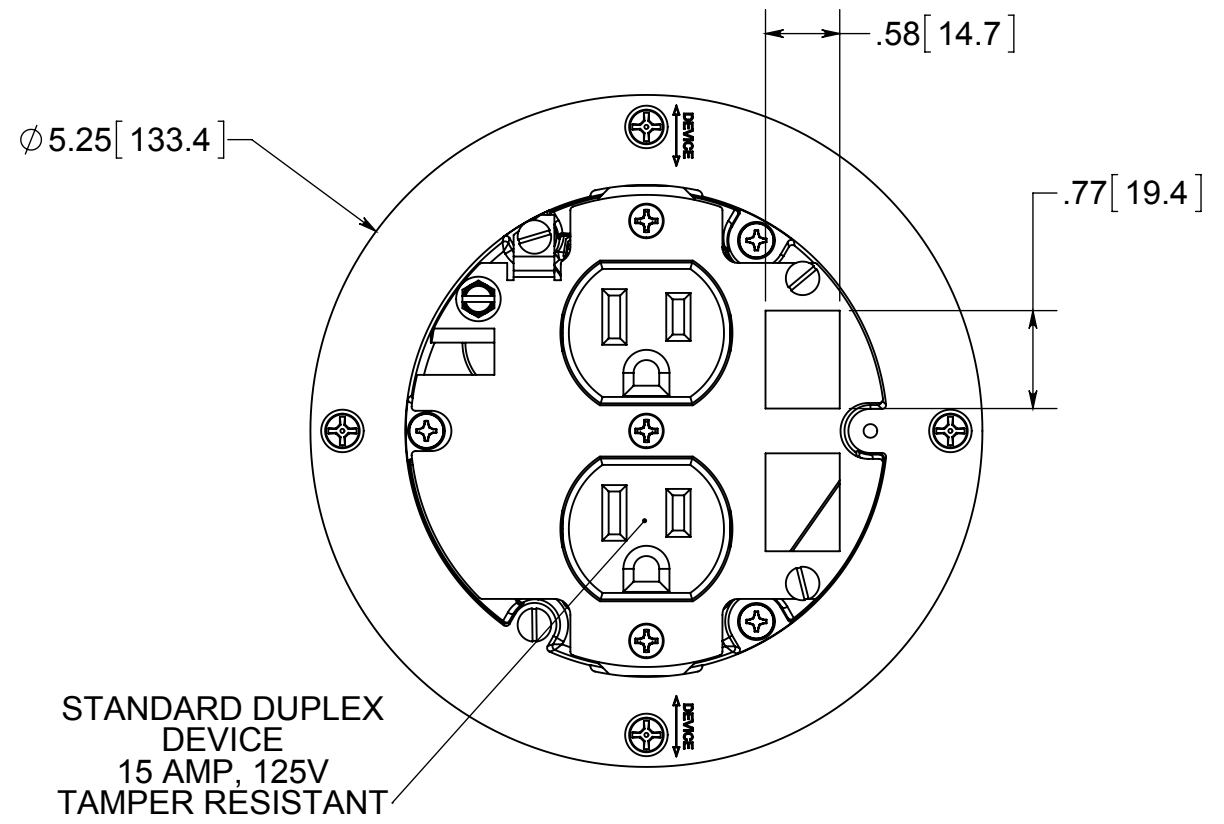

- NOTES:
- 1.) BOX MATERIAL: POLYCARBONATE, COVER PLATE MATERIAL: DARK BRONZE PLATED BRASS, COVER PLATE MOUNTING SCREW MATERIAL: DARK BRONZE PLATED BRASS, DEVICE SCREW MATERIALS: ZINC PLATED STEEL, FLANGE MOUNTING SCREW MATERIAL: BLACK PHOSPHATE COATED STEEL WING MATERIAL: ZINC PLATED STEEL, GROUND PLATE MATERIAL: ZINC PLATED STEEL, GASKET MATERIALS: POLYURETHANE FOAM, O-RING MATERIAL: SILICONE
 - 2.) UL LISTED, FLOOR BOX MEETS UL514C SCRUB WATER EXCLUSION TEST

 **ALLIED MOULDED PRODUCTS**
BRYAN, OHIO
The Original Fiber Glass Outlet Box

PRODUCT SERIES
ROUND FLIP LID FLOOR BOX

Part No.
FB-8DB

CONFIDENTIAL
THIS MATERIAL IS OWNED BY THE ALLIED MOULDED PRODUCTS COMPANY, IS DISCLOSED IN CONFIDENCE, AND IS NOT TO BE REPRODUCED OR DISTRIBUTED WITHOUT PRIOR WRITTEN PERMISSION FROM ALLIED MOULDED PRODUCTS.