

# **ULTRALINE<sup>®</sup>**

From Allied Moulded Products 

## **Aluminum Hinged Front Panel**

### **Installation Instructions**

# **HFPU186**



**ALLIED  
MOULDED  
PRODUCTS, Inc.**

222 N. Union St. Bryan, OH 43506  
PH: 419-636-4217 • FAX: 800-237-7269

[www.alliedmoulded.com](http://www.alliedmoulded.com)

INST-HFPU186

# HFPU186 ASSEMBLY

1

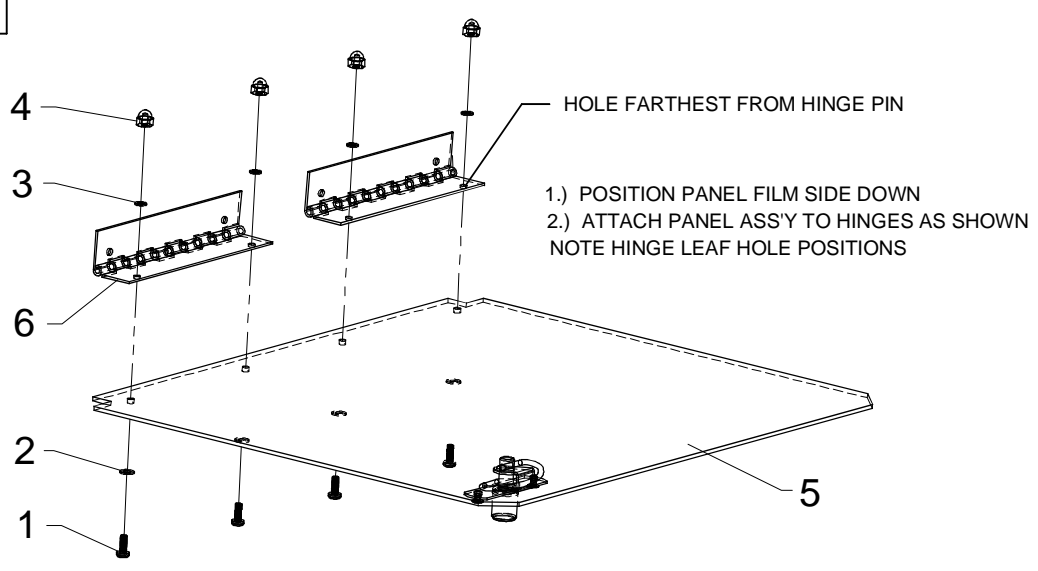

- HFPU186**
- 1) #6-32 x 3/8 SCREW (4)
  - 2) #6 FLAT WASHER (12)
  - 3) #6 LOCK WASHER (8)
  - 4) #6-32 ACORN NUT (8)
  - 5) U60833 PANEL/LATCH ASS'Y (1)
  - 6) 70-60804 5" HINGE (2)
  - 7) 70-UPANST186 PANEL STOP (1)
  - 8) 70-UPANST186EX EXTEND PANEL STOP (1)
  - 9) #10-32 x 5/16 SCREW (2)
  - 10) #10-32 x 7/16 SCREW (2)
  - 11) #6-32 x 3/4 SCREW (4)
  - 12) 70-UDGS186 DRILL GUIDE (2)
  - 13) 70-60431NYLON (4)

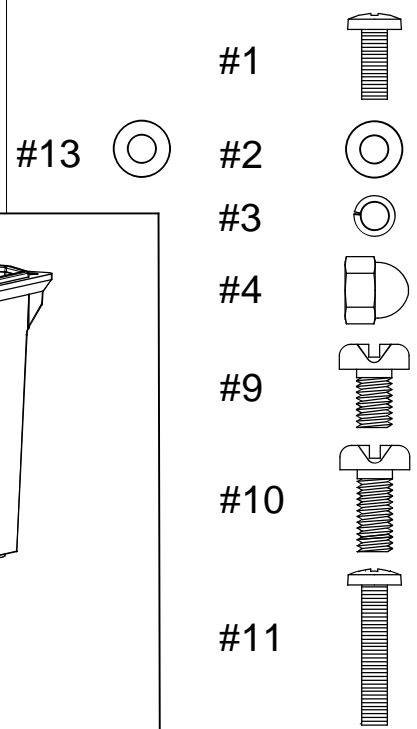

2

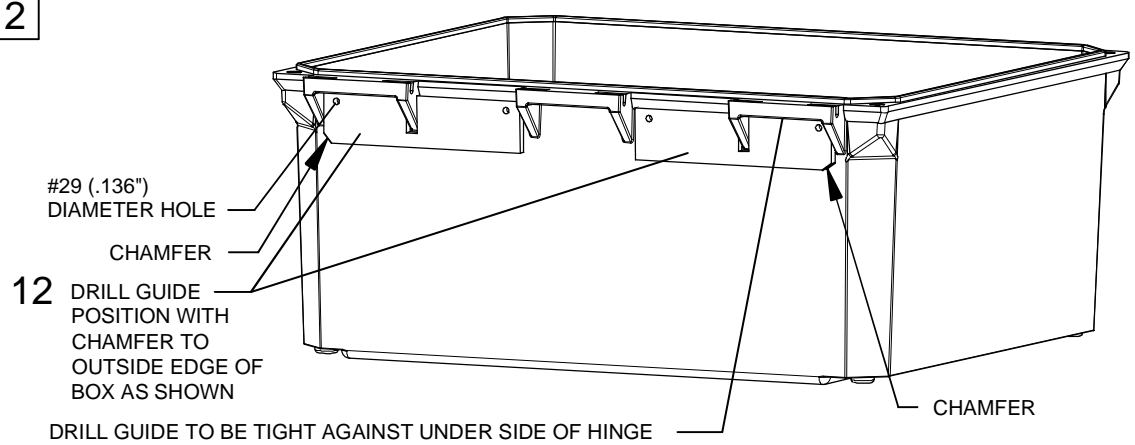

- 1) POSITION DRILL GUIDE PLATES AS SHOWN, **DRILL GUIDES TO BE USED AS SPACER IN STEP #3**
- 2) DRILL FOUR #29 (.136") DIAMETER HOLES

3

- 1) PLACE WASHER #13 ONTO SCREW #11 AND INSERT #11 & #13 THROUGH WALL OF BOX, PLACE DRILL GUIDE #12 (USED AS SPACER) BETWEEN THE BOX INSIDE WALL AND HINGE #6
- 2) ASSEMBLE PANEL STOPS #7 & #8 WITH TWO SCREWS #9 OR #10 WITH ENCLOSURE BACK PANEL. PANEL STOPS SHOULD LAY AGAINST THE BOX WALL

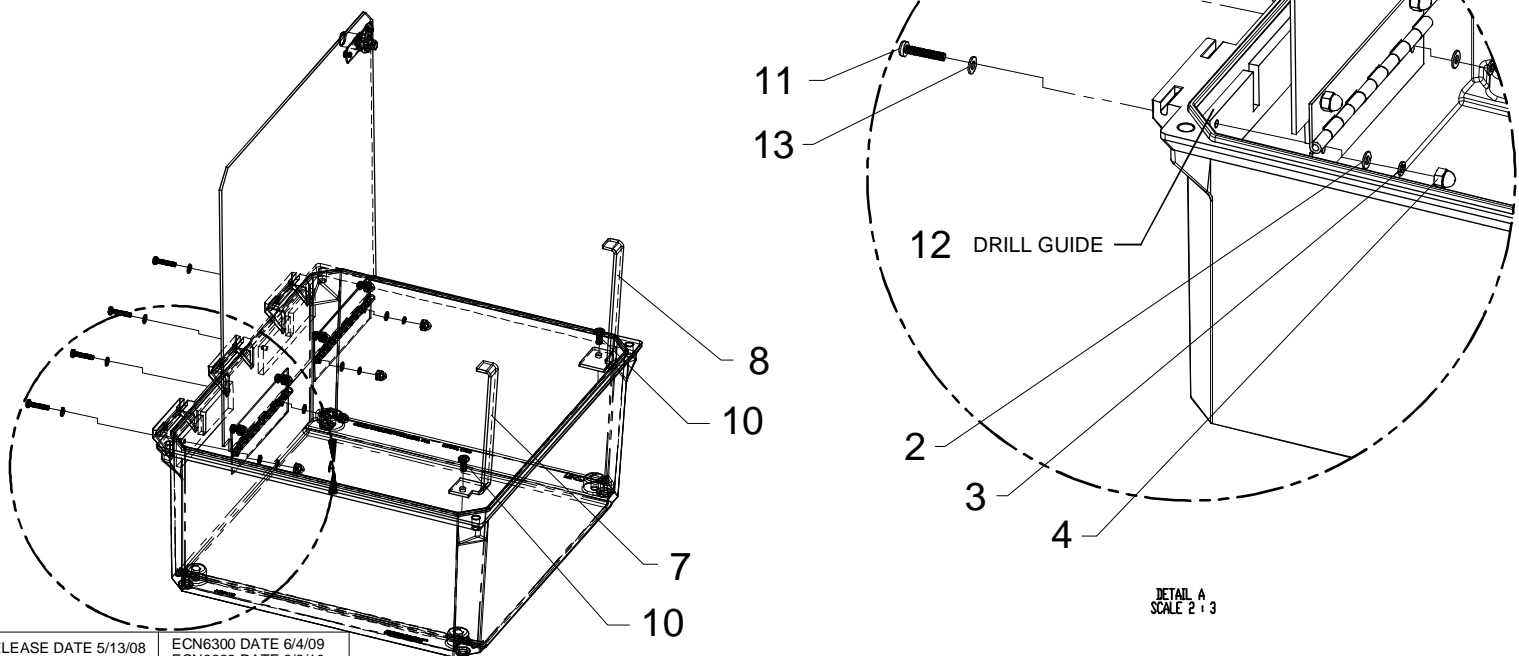

DETAIL A  
SCALE 2:3