

FRONT VIEW WITH COVER REMOVED AND BACK PANEL SHOWN

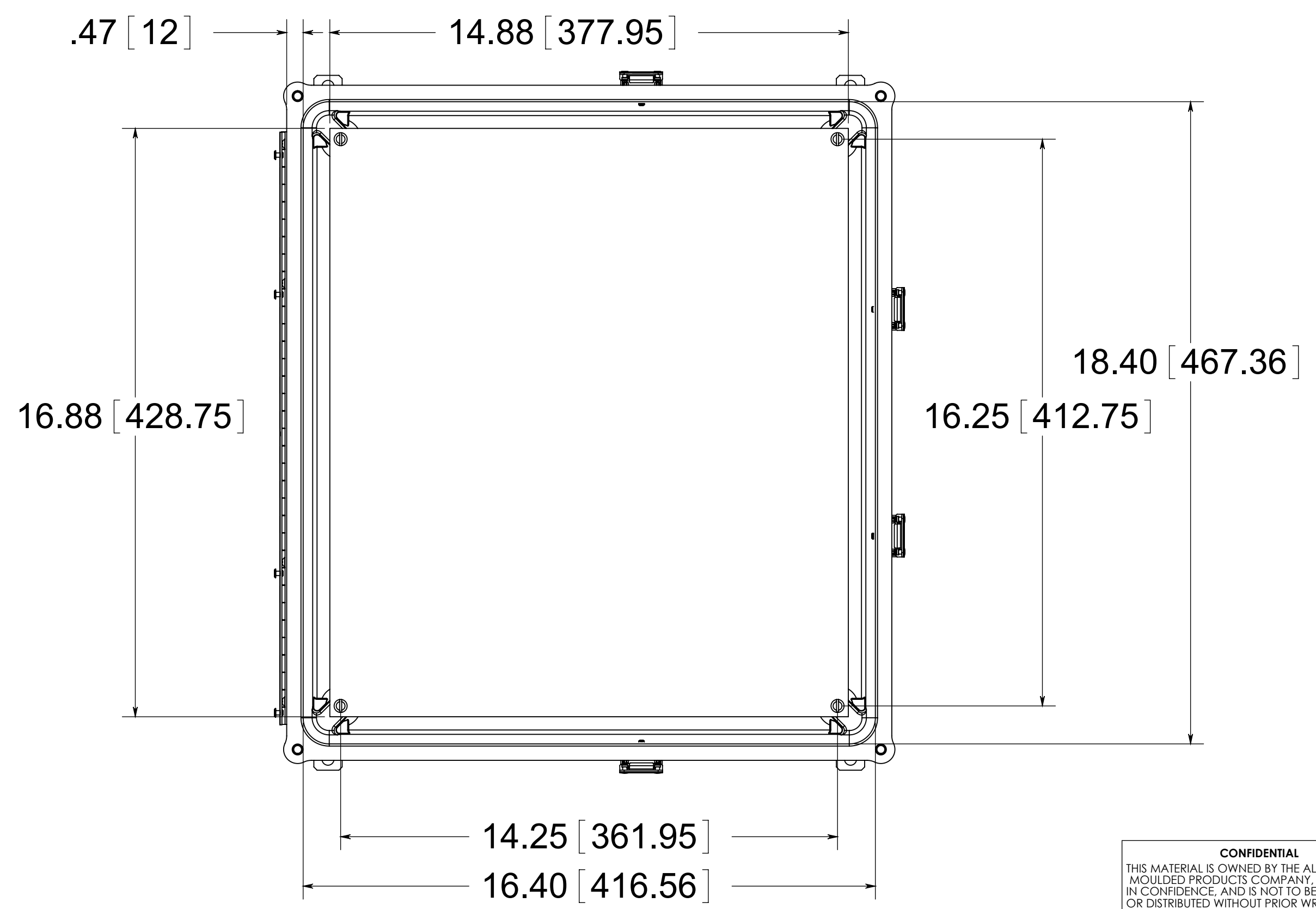
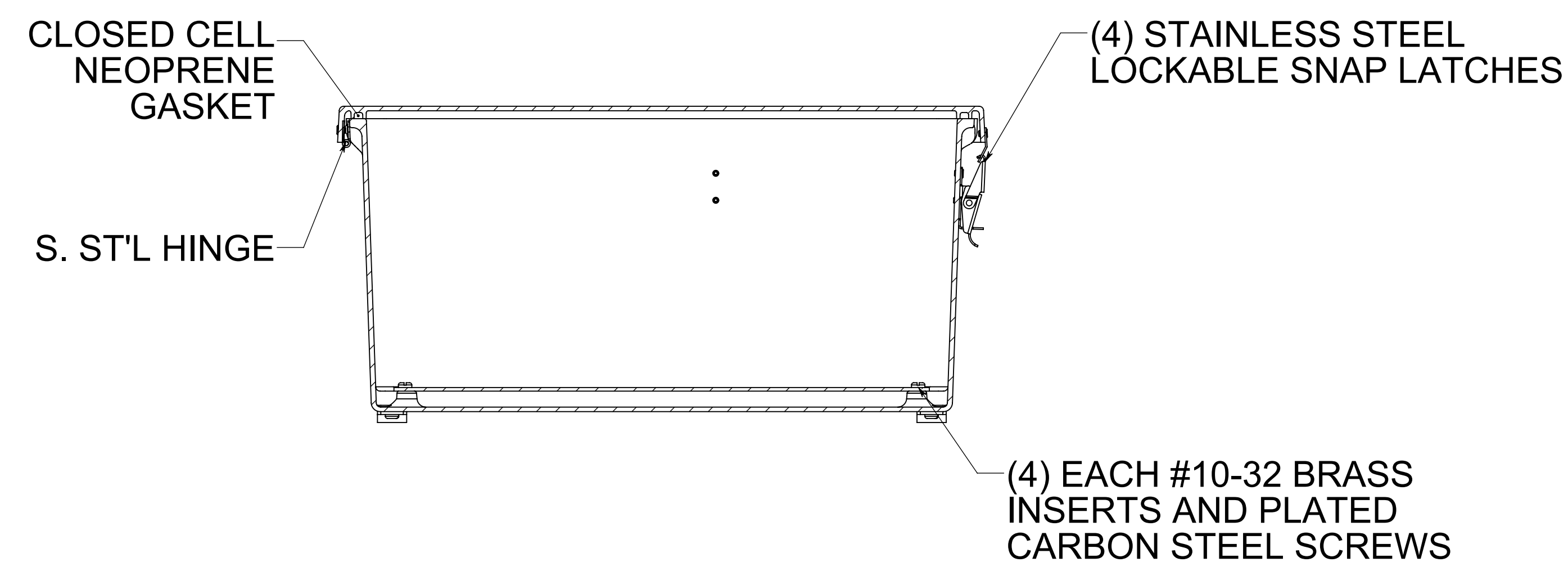

MATERIAL:
 BOX- COMPRESSION MOLDED FIBERGLASS REINFORCED POLYESTER
 COVER- COMPRESSION MOLDED FIBERGLASS REINFORCED POLYESTER
 WINDOWS- POLYCARBONATE

CONFIDENTIAL
 THIS MATERIAL IS OWNED BY THE ALLIED MOULDED PRODUCTS COMPANY, IS DISCLOSED IN CONFIDENCE, AND IS NOT TO BE REPRODUCED OR DISTRIBUTED WITHOUT PRIOR WRITTEN PERMISSION FROM ALLIED MOULDED PRODUCTS.

ALLIED MOULDED PRODUCTS
 BRYAN, OHIO
 The Original Fiber Glass Outlet Box

Description
AM1868L
 Part No.
AM1868L