

fiberglass BOX™

ISSUE DATE: 06/17/2015

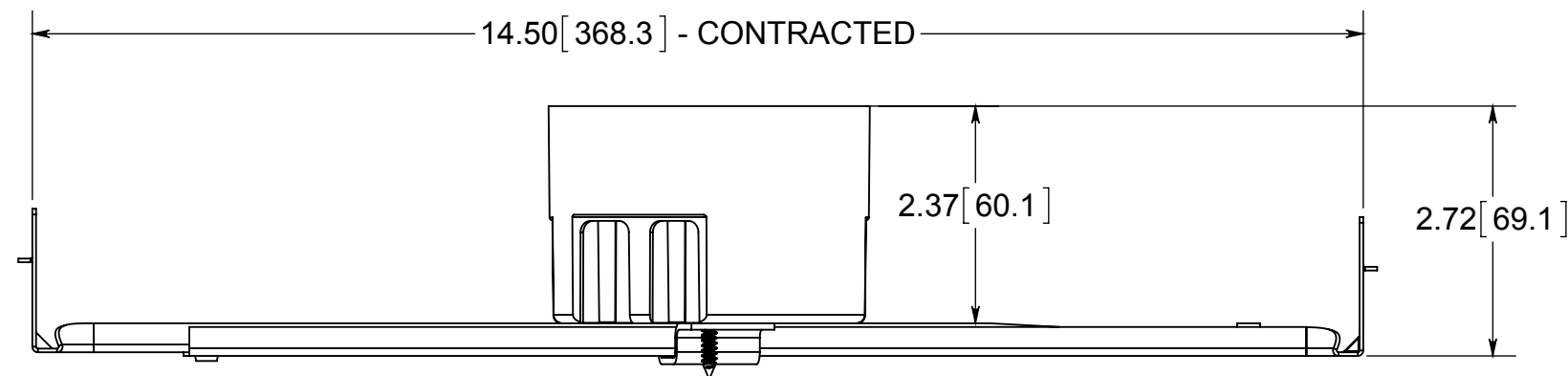
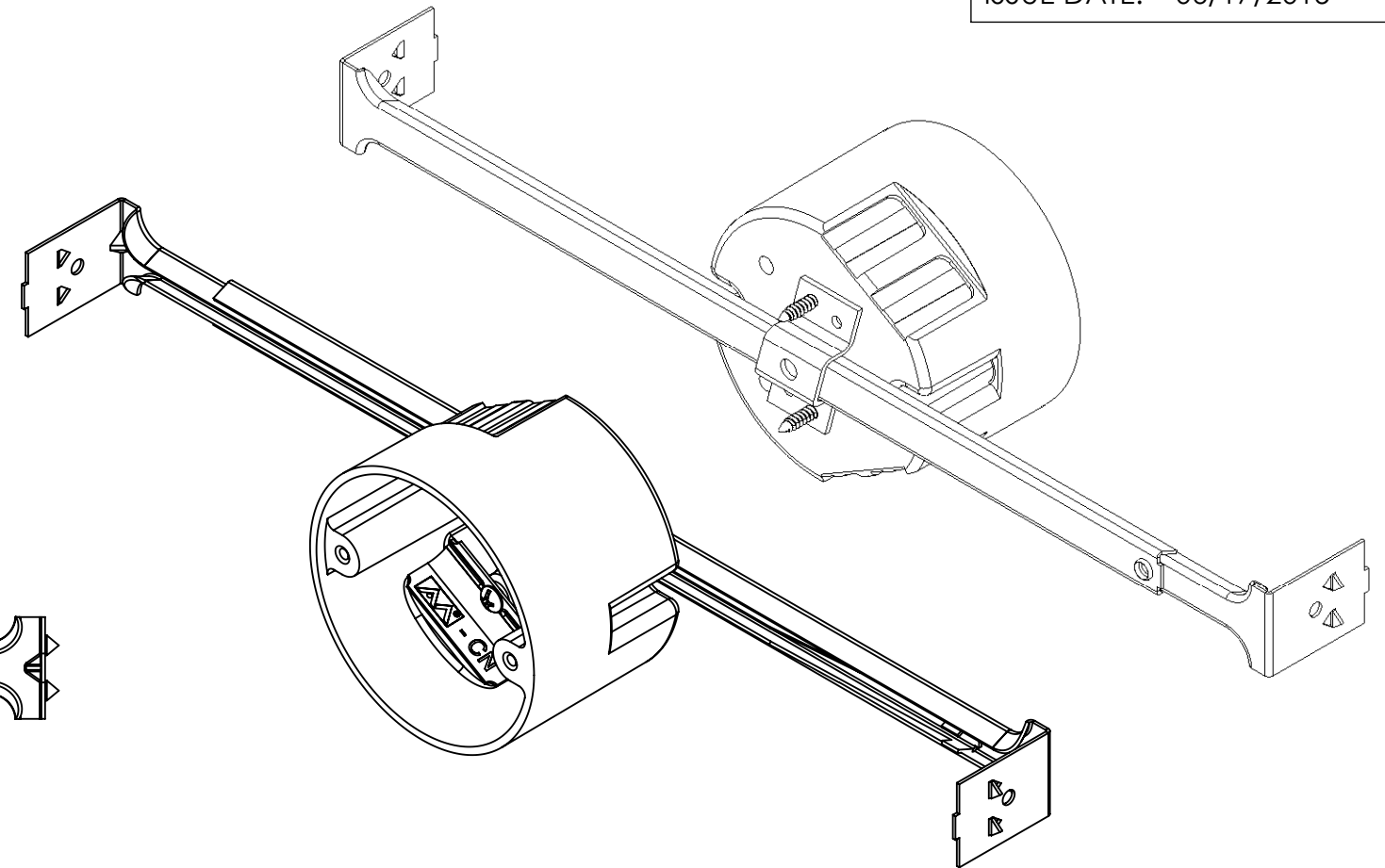
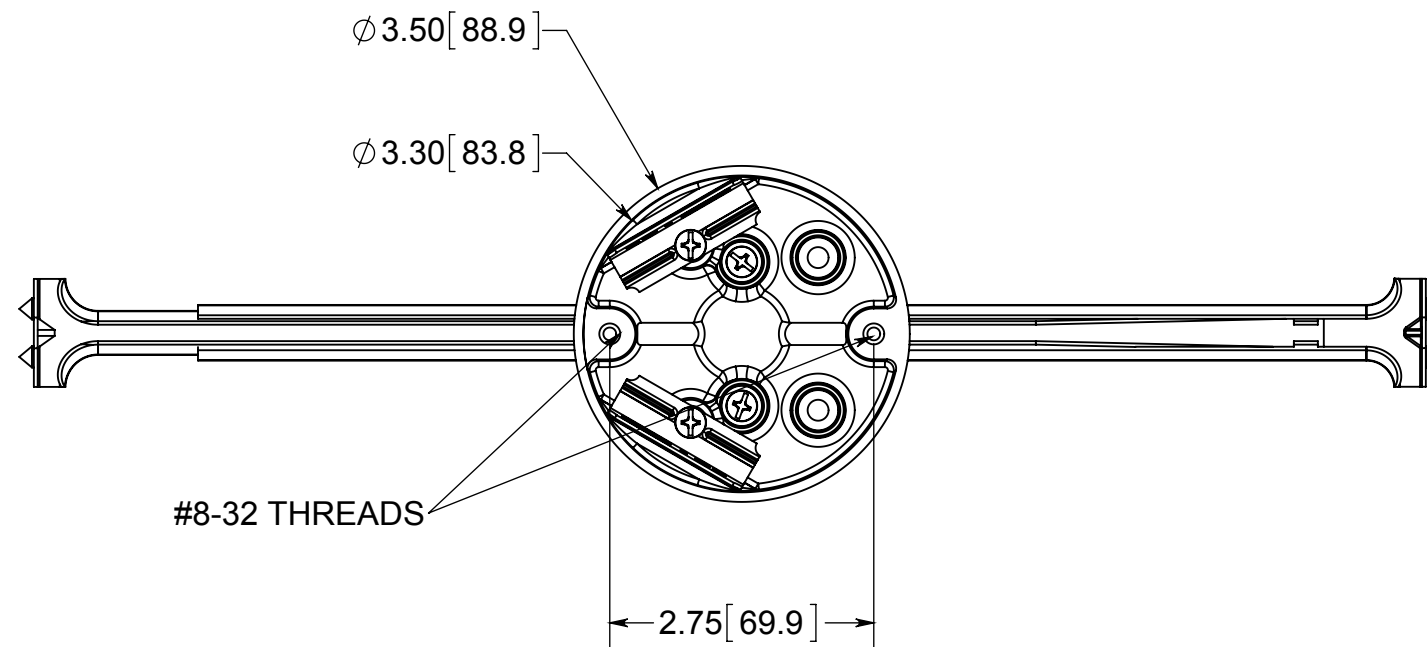

NOTES:

- 1.) BOX MATERIAL: FIBERGLASS REINFORCED POLYESTER, WIRE CLAMP MATERIAL: GALVANIZED STEEL, WIRE CLAMP SCREW MATERIAL: ZINC PLATED STEEL, BAR MATERIAL: GALVANIZED STEEL, MOUNTING BRACKET MATERIAL: GALVANIZED STEEL, MOUNTING BRACKET SCREW MATERIAL: ZINC PLATED STEEL
- 2.) UL LISTED WITH 2 HOUR FIRE RATING FOR WALL AND CEILING
- 3.) 2 WIRE CLAMPS FACTORY INSTALLED



® **ALLIED MOULDED PRODUCTS**
BRYAN, OHIO

The Original Fiber Glass Outlet Box

PRODUCT SERIES

3-1/2" ROUND 16.0 CU. IN.

Part No.

9336-16C2

CONFIDENTIAL

THIS MATERIAL IS OWNED BY THE ALLIED MOULDED PRODUCTS COMPANY, IS DISCLOSED IN CONFIDENCE, AND IS NOT TO BE REPRODUCED OR DISTRIBUTED WITHOUT PRIOR WRITTEN PERMISSION FROM ALLIED MOULDED PRODUCTS.